

Sezgin

Üreten Ülke Güçlüdür...



Fiyat Listesi / Aralık 2017



EROLLAR ELEKTRİK

İÇİNDEKİLER

TO.B, TO.30D, TO.30 ALÇAK GERİLİM AKIM TRAFOLARI	2
TO.30 M, TO.40, TO.60 ALÇAK GERİLİM AKIM TRAFOLARI	3
TO.80, TO.100, TO.120 ALÇAK GERİLİM AKIM TRAFOLARI	4
TO.60DR, TO.100DR ALÇAK GERİLİM AKIM TRAFOLARI	5
TOROİDAL TİP AKIM TRAFOLARI (SİMİT)	6-7
TEK FAZLI ŞÖNT REAKTÖRLER	8
ÜÇ FAZLI ŞÖNT REAKTÖRLER	8
ÜÇ FAZLI HARMONİK FİLTRELER	8
ŞÖNT REAKTÖRLER BOYUT VE AĞIRLIKLARI	9
HARMONİK FİLTRE BOYUT VE AĞIRLIKLARI	9
KUMANDA TRAFOLARI	10
İZOLASYON TRAFOLARI	10
AC SİLİNDİRİK TÜP KONDANSATÖRLER, KOMPANZASYON KONTAKTÖRLERİ	11-12
DELİKLİ KABLO KANALLARI	14
ISITICILAR	14
TEPE FANLARI	14
TERMOSTATLAR	14
80A TOPRAKLAMA KLEMENSLERİ	15
80A NÖTR KLEMENSLERİ (AYAKLI)	15
80A NÖTR KLEMENSLERİ (AYAKSIZ)	15
125A NÖTR KLEMENSLERİ (AYAKLI)	16
125A NÖTR KLEMENSLERİ (AYAKSIZ)	16
OTOMAT BARASI	16
OTOMAT RAYI	16
DAĞITIM ÜNİTELERİ	17
SİNYAL LAMBALARI	18
STANDART TİP SKP KABLO PABUCU, LED'Lİ BANT ARMATÜRLER	18
DARALAN MAKARONLAR	19
SERTİFİKALAR	20

TO.B ALÇAK GERİLİM AKIM TRAFOLARI / LOW VOLTAGE CURRENT TRANSFORMERS

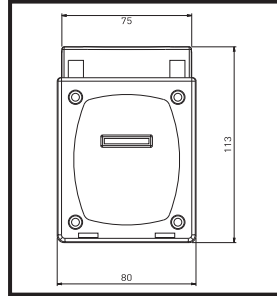
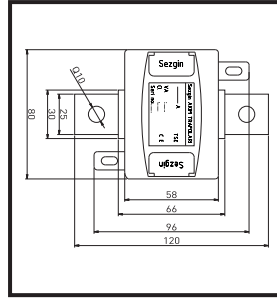

Anma Akımı(A) Rated Current(A) Bemessungstrom(A)	Sınıf Accuracy Class Genauigkeit	Güç(VA) Power(VA) Leistungs(VA)	Fiyat/TL Price Preis
5/5 - 10/5 - 15/5 - 20/5 - 25/5 30/5 - 40/5 - 50/5 - 60/5 - 75/5 80/5 - 100/5 - 125/5 - 150/5	0,5 - 1	5	54,90 TL
		10	54,90 TL
		15	56,40 TL
200/5 - 250/5 - 300/5 400/5 - 500/5 - 600/5	0,5 - 1	5	70,90 TL
		10	72,30 TL
		15	73,80 TL
Mühürlü Tip / Sealed Type			
5/5 - 10/5 - 15/5 - 20/5 - 25/5 30/5 - 40/5 - 50/5 - 60/5 - 75/5 80/5 - 100/5 - 125/5 - 150/5	0,5	10	62,90 TL

TO.30D ALÇAK GERİLİM AKIM TRAFOLARI / LOW VOLTAGE CURRENT TRANSFORMERS

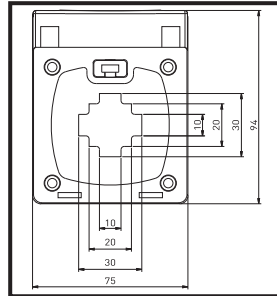
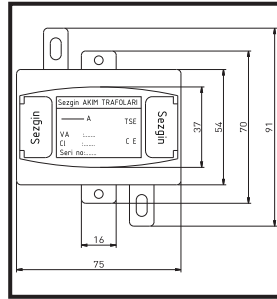

Anma Akımı(A) Rated Current(A) Bemessungstrom(A)	Sınıf Accuracy Class Genauigkeit	Güç(VA) Power(VA) Leistungs(VA)	Fiyat/TL Price Preis
200/5	0,5 - 1	5	43,20 TL
		10	45,90 TL
		15	48,45 TL
Mühürlü Tip / Sealed Type			
200/5	0,5	10	53,90TL

TO.30 ALÇAK GERİLİM AKIM TRAFOLARI / LOW VOLTAGE CURRENT TRANSFORMERS

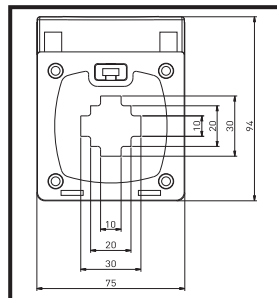
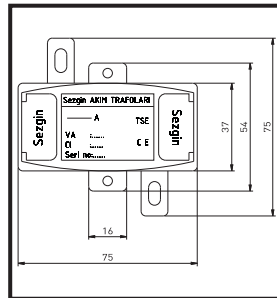

Anma Akımı(A) Rated Current(A) Bemessungstrom(A)	Sınıf Accuracy Class Genauigkeit	Güç(VA) Power(VA) Leistungs(VA)	Fiyat/TL Price Preis
250/5 - 300/5 400/5 - 500/5 - 600/5	0,5 - 1	5	46,50 TL
		10	47,20 TL
		15	48,65 TL
20/5 - 25/5 - 30/5 - 40/5 50/5 - 60/5 - 75/5 - 80/5 100/5 - 125/5 - 150/5	1	5	49,30 TL
Mühürlü Tip / Sealed Type			
250/5 - 300/5	0,5	10	55,20 TL

TO.30M ALÇAK GERİLİM AKIM TRAFOLARI / LOW VOLTAGE CURRENT TRANSFORMERS



**Raya Montajlanabilir
Rail Mounting**

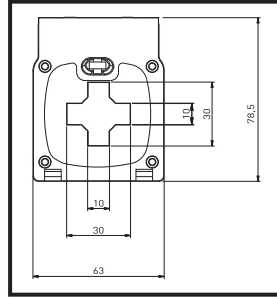
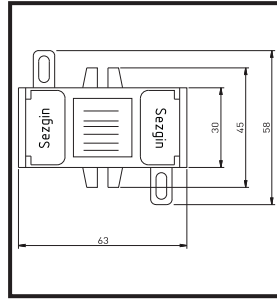

Anma Akımı(A) Rated Current(A) Bemessungstrom(A)	Sınıf Accuracy Class Genauigkeit	Güç(VA) Power(VA) Leistungs(VA)	Fiyat/TL Price Preis
50/5 - 60/5 - 75/5 - 80/5 100/5 - 125/5 - 150/5	1	1,5	43,50 TL
100/5 - 125/5 - 150/5 - 200/5	0,5	1,5	43,50 TL
150/5 - 200/5	0,5	2,5	43,50 TL
200/5 - 250/5 - 300/5 400/5 - 500/5 - 600/5	0,5	5	44,10 TL
300/5 - 400/5 500/5 - 600/5	0,5	10	47,50 TL
Raya Montaj Aparatı			1,70 TL

TO.40 ALÇAK GERİLİM AKIM TRAFOLARI / LOW VOLTAGE CURRENT TRANSFORMERS

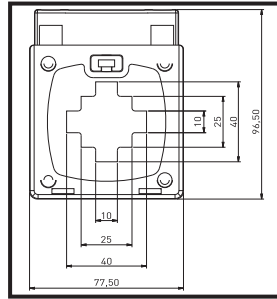
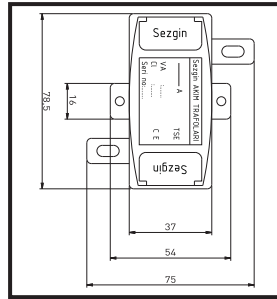

Anma Akımı(A) Rated Current(A) Bemessungstrom(A)	Sınıf Accuracy Class Genauigkeit	Güç(VA) Power(VA) Leistungs(VA)	Fiyat/TL Price Preis
300/5	0,5 - 1	5	46,70 TL
400/5		10	47,50 TL
500/5		15	48,90 TL
600/5			
Mühürlü Tip / Sealed Type			
400/5 - 500/5 - 600/5	0,5	10	55,50 TL

TO.60 ALÇAK GERİLİM AKIM TRAFOLARI / LOW VOLTAGE CURRENT TRANSFORMERS

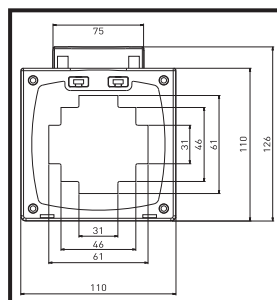
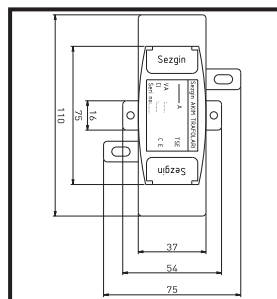

Anma Akımı(A) Rated Current(A) Bemessungstrom(A)	Sınıf Accuracy Class Genauigkeit	Güç(VA) Power(VA) Leistungs(VA)	Fiyat/TL Price Preis
700/5 - 750/5 - 800/5	0,5 - 1	5	54,80 TL
		10	58,40 TL
		15	65,70 TL
1000/5 - 1200/5 - 1250/5	0,5 - 1	5	59,90 TL
		10	64,30 TL
		15	71,60 TL
Mühürlü Tip / Sealed Type			
700/5 - 750/5 - 800/5	0,5	10	66,40 TL
1000/5 - 1200/5 - 1250/5	0,5	10	72,30 TL

TO.80 ALÇAK GERİLİM AKIM TRAFOLARI / LOW VOLTAGE CURRENT TRANSFORMERS

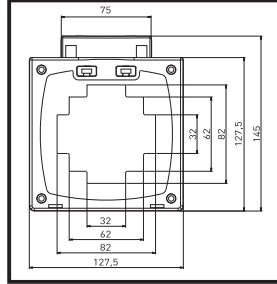
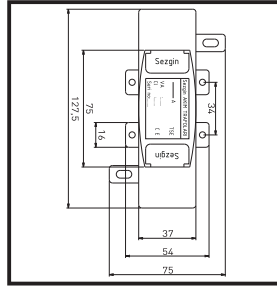

Anma Akımı(A) Rated Current(A) Bemessungstrom(A)	Sınıf Accuracy Class Genauigkeit	Güç(VA) Power(VA) Leistungs(VA)	Fiyat/TL Price Preis
1500/5 - 1600/5	0,5 - 1	15	87,50 TL
		30	93,40 TL
Mühürlü Tip / Sealed Type			
1500/5 - 1600/5	0,5	15	95,50 TL

TO.100 ALÇAK GERİLİM AKIM TRAFOLARI / LOW VOLTAGE CURRENT TRANSFORMERS

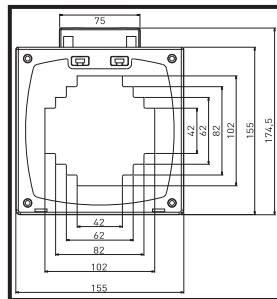
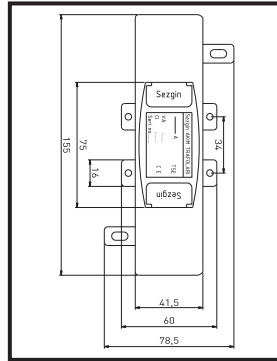

Anma Akımı(A) Rated Current(A) Bemessungstrom(A)	Sınıf Accuracy Class Genauigkeit	Güç(VA) Power(VA) Leistungs(VA)	Fiyat/TL Price Preis
2000/5	0,5 - 1	15	102,30 TL
		30	107,20 TL
2500/5	0,5 - 1	15	111,10 TL
		30	117,00 TL
3000/5	0,5 - 1	15	131,90 TL
		30	137,70 TL
3200/5	0,5 - 1	15	134,70 TL
		30	141,90 TL
4000/5	0,5 - 1	30	151,90 TL
5000/5	0,5 - 1	30	189,90 TL
Mühürlü Tip / Sealed Type			
2000/5	0,5	15	110,30 TL
2500/5	0,5	15	119,10 TL
3000/5	0,5	15	139,90 TL
3200/5	0,5	15	142,70 TL

TO.120 ALÇAK GERİLİM AKIM TRAFOLARI / LOW VOLTAGE CURRENT TRANSFORMERS

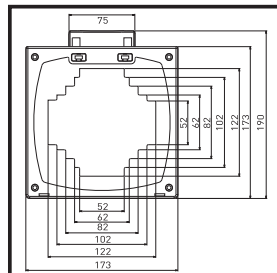
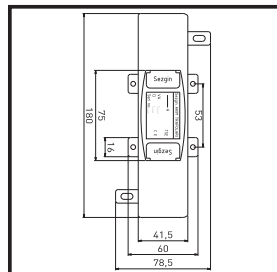

Anma Akımı(A) Rated Current(A) Bemessungstrom(A)	Sınıf Accuracy Class Genauigkeit	Güç(VA) Power(VA) Leistungs(VA)	Fiyat/TL Price Preis
2000/5	0,5 - 1	15	113,15 TL
		30	118,30 TL
2500/5	0,5 - 1	15	119,80 TL
		30	125,80 TL
3000/5	0,5 - 1	15	142,75 TL
		30	148,60 TL
3200/5	0,5 - 1	15	144,95 TL
		30	152,30 TL
4000/5	0,5 - 1	30	162,80 TL
5000/5	0,5 - 1	30	207,10 TL

TO.60DR ALÇAK GERİLİM AKIM TRAFOLARI / LOW VOLTAGE CURRENT TRANSFORMERS

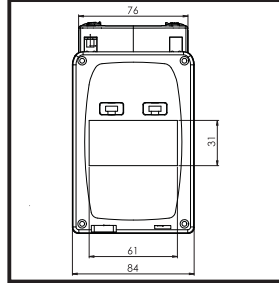
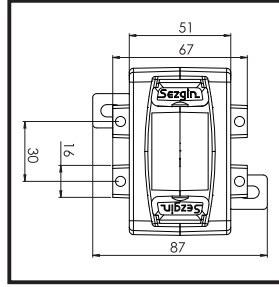

Anma Akımı(A) Rated Current(A) Bemessungstrom(A)	Sınıf Accuracy Class Genauigkeit	Güç(VA) Power(VA) Leistungs(VA)	Fiyat/TL Price Preis
400/5	0,5 - 1	5	61,75 TL
		10	61,75 TL
500/5 - 600/5	0,5 - 1	5	63,25 TL
		10	63,25 TL
		15	65,80 TL
700/5 - 750/5 - 800/5	0,5 - 1	5	64,50 TL
		10	64,50 TL
		15	72,25 TL
1000/5 - 1200/5 - 1250/5	0,5 - 1	5	70,80 TL
		10	70,80 TL
		15	78,50 TL
1500/5 - 1600/5	0,5 - 1	15	90,50 TL
		30	93,40 TL
2000/5	0,5 - 1	15	91,75 TL
		30	94,50 TL

TO.100DR ALÇAK GERİLİM AKIM TRAFOLARI / LOW VOLTAGE CURRENT TRANSFORMERS

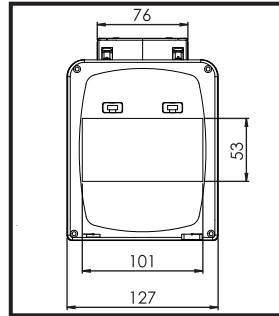
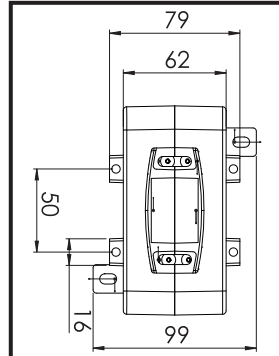

Anma Akımı(A) Rated Current(A) Bemessungstrom(A)	Sınıf Accuracy Class Genauigkeit	Güç(VA) Power(VA) Leistungs(VA)	Fiyat/TL Price Preis
1000/5 - 1200/5 - 1250/5	0,5 - 1	10	90,30 TL
		15	95,70 TL
1500/5 - 1600/5	0,5 - 1	10	110,40 TL
		15	113,30 TL
2000/5	0,5 - 1	30	115,50 TL
		15	112,50 TL
2500/5	0,5 - 1	30	117,90 TL
		15	122,20 TL
3000/5	0,5 - 1	30	128,70 TL
		15	145,10 TL
3200/5	0,5 - 1	30	151,40 TL
		15	148,20 TL
4000/5	0,5 - 1	30	156,10 TL
		15	167,10 TL
5000/5	0,5 - 1	30	210,90 TL

TOROİDAL TİP AKIM TRAFOLARI / TOROIDAL CURRENT TRANSFORMERS

STO.20

İÇ ÇAP 21mm DIŞ ÇAP 63,50mm



ÜRÜN KODU PRODUCT CODE	AÇIKLAMA / STOK CİNSİ DESCRIPTION TYPE	BİRİM UNIT	FİYAT (TL) PRICE
STO203035	30/5 CL:3 5VA TOROİDAL AKIM TRAFOSU (SİMİT)	ADET	30,80 TL
STO204035	40/5 CL:3 5VA TOROİDAL AKIM TRAFOSU (SİMİT)	ADET	30,80 TL
STO205035	50/5 CL:3 5VA TOROİDAL AKIM TRAFOSU (SİMİT)	ADET	30,80 TL
STO206035	60/5 CL:3 5VA TOROİDAL AKIM TRAFOSU (SİMİT)	ADET	30,80 TL
STO207535	75/5 CL:3 5VA TOROİDAL AKIM TRAFOSU (SİMİT)	ADET	30,80 TL
STO208035	80/5 CL:3 5VA TOROİDAL AKIM TRAFOSU (SİMİT)	ADET	30,80 TL
STO2010035	100/5 CL:3 5VA TOROİDAL AKIM TRAFOSU (SİMİT)	ADET	30,80 TL
STO2012535	125/5 CL:3 5VA TOROİDAL AKIM TRAFOSU (SİMİT)	ADET	30,80 TL
STO2015035	150/5 CL:3 5VA TOROİDAL AKIM TRAFOSU (SİMİT)	ADET	30,80 TL
STO2020035	200/5 CL:3 5VA TOROİDAL AKIM TRAFOSU (SİMİT)	ADET	30,80 TL
STO2025035	250/5 CL:3 5VA TOROİDAL AKIM TRAFOSU (SİMİT)	ADET	30,80 TL
STO2030035	300/5 CL:3 5VA TOROİDAL AKIM TRAFOSU (SİMİT)	ADET	30,80 TL

STO.30

İÇ ÇAP 31mm DIŞ ÇAP 72,50mm



ÜRÜN KODU PRODUCT CODE	AÇIKLAMA / STOK CİNSİ DESCRIPTION TYPE	BİRİM UNIT	FİYAT (TL) PRICE
STO303035	30/5 CL:3 5VA TOROİDAL AKIM TRAFOSU (SİMİT)	ADET	30,80 TL
STO304035	40/5 CL:3 5VA TOROİDAL AKIM TRAFOSU (SİMİT)	ADET	30,80 TL
STO305035	50/5 CL:3 5VA TOROİDAL AKIM TRAFOSU (SİMİT)	ADET	30,80 TL
STO306035	60/5 CL:3 5VA TOROİDAL AKIM TRAFOSU (SİMİT)	ADET	30,80 TL
STO307535	75/5 CL:3 5VA TOROİDAL AKIM TRAFOSU (SİMİT)	ADET	30,80 TL
STO308035	80/5 CL:3 5VA TOROİDAL AKIM TRAFOSU (SİMİT)	ADET	30,80 TL
STO3010035	100/5 CL:3 5VA TOROİDAL AKIM TRAFOSU (SİMİT)	ADET	30,80 TL
STO3012535	125/5 CL:3 5VA TOROİDAL AKIM TRAFOSU (SİMİT)	ADET	30,80 TL
STO3015035	150/5 CL:3 5VA TOROİDAL AKIM TRAFOSU (SİMİT)	ADET	30,80 TL
STO3020035	200/5 CL:3 5VA TOROİDAL AKIM TRAFOSU (SİMİT)	ADET	30,80 TL
STO3025035	250/5 CL:3 5VA TOROİDAL AKIM TRAFOSU (SİMİT)	ADET	30,80 TL
STO3030035	300/5 CL:3 5VA TOROİDAL AKIM TRAFOSU (SİMİT)	ADET	30,80 TL

STO.40

İÇ ÇAP 41mm DIŞ ÇAP 76,50mm



ÜRÜN KODU PRODUCT CODE	AÇIKLAMA / STOK CİNSİ DESCRIPTION TYPE	BİRİM UNIT	FİYAT (TL) PRICE
STO4010035	100/5 CL:3 5VA TOROİDAL AKIM TRAFOSU (SİMİT)	ADET	30,80 TL
STO4015035	150/5 CL:3 5VA TOROİDAL AKIM TRAFOSU (SİMİT)	ADET	30,80 TL
STO4020035	200/5 CL:3 5VA TOROİDAL AKIM TRAFOSU (SİMİT)	ADET	30,80 TL
STO4025035	250/5 CL:3 5VA TOROİDAL AKIM TRAFOSU (SİMİT)	ADET	30,80 TL
STO4030035	300/5 CL:3 5VA TOROİDAL AKIM TRAFOSU (SİMİT)	ADET	30,80 TL
STO4040035	400/5 CL:3 5VA TOROİDAL AKIM TRAFOSU (SİMİT)	ADET	30,80 TL
STO4050035	500/5 CL:3 5VA TOROİDAL AKIM TRAFOSU (SİMİT)	ADET	30,80 TL
STO4060035	600/5 CL:3 5VA TOROİDAL AKIM TRAFOSU (SİMİT)	ADET	30,80 TL

TOROİDAL TİP AKIM TRAFOLARI / TOROIDAL CURRENT TRANSFORMERS

STO.60
İÇ ÇAP 61mm
DIŞ ÇAP 110mm

STO.80
İÇ ÇAP 81mm
DIŞ ÇAP 127mm



ÜRÜN KODU PRODUCT CODE	AÇIKLAMA / STOK CİNSİ DESCRIPTION TYPE	BİRİM UNIT	FİYAT (TL) PRICE
STO6070035	700/5 CL:3 5VA TOROİDAL AKIM TRAFOSU (SİMİT)	ADET	49,10 TL
STO6075035	750/5 CL:3 5VA TOROİDAL AKIM TRAFOSU (SİMİT)	ADET	49,10 TL
STO6080035	800/5 CL:3 5VA TOROİDAL AKIM TRAFOSU (SİMİT)	ADET	49,10 TL
STO60100035	1000/5 CL:3 5VA TOROİDAL AKIM TRAFOSU (SİMİT)	ADET	53,95 TL
STO60120035	1200/5 CL:3 5VA TOROİDAL AKIM TRAFOSU (SİMİT)	ADET	53,95 TL
STO601250035	1250/5 CL:3 5VA TOROİDAL AKIM TRAFOSU (SİMİT)	ADET	53,95 TL
ÜRÜN KODU PRODUCT CODE	AÇIKLAMA / STOK CİNSİ DESCRIPTION TYPE	BİRİM UNIT	FİYAT (TL) PRICE
STO80150035	1500/5 CL:3 5VA TOROİDAL AKIM TRAFOSU (SİMİT)	ADET	73,70 TL
STO80160035	1600/5 CL:3 5VA TOROİDAL AKIM TRAFOSU (SİMİT)	ADET	73,70 TL



STO.100 İÇ ÇAP 101mm DIŞ ÇAP 150mm



ÜRÜN KODU PRODUCT CODE	AÇIKLAMA / STOK CİNSİ DESCRIPTION TYPE	BİRİM UNIT	FİYAT (TL) PRICE
STO100200035	2000/5 CL:3 5VA TOROİDAL AKIM TRAFOSU (SİMİT)	ADET	87,75 TL
STO100250035	2500/5 CL:3 5VA TOROİDAL AKIM TRAFOSU (SİMİT)	ADET	93,25 TL
STO100300035	3000/5 CL:3 5VA TOROİDAL AKIM TRAFOSU (SİMİT)	ADET	112,35 TL
STO100320035	3200/5 CL:3 5VA TOROİDAL AKIM TRAFOSU (SİMİT)	ADET	114,10 TL
STO100400035	4000/5 CL:3 5VA TOROİDAL AKIM TRAFOSU (SİMİT)	ADET	128,90 TL
STO100500035	5000/5 CL:3 5VA TOROİDAL AKIM TRAFOSU (SİMİT)	ADET	159,50 TL

STO.125 İÇ ÇAP 126mm DIŞ ÇAP 172mm



ÜRÜN KODU PRODUCT CODE	AÇIKLAMA / STOK CİNSİ DESCRIPTION TYPE	BİRİM UNIT	FİYAT (TL) PRICE
STO120200035	2000/5 CL:3 5VA TOROİDAL AKIM TRAFOSU (SİMİT)	ADET	93,85 TL
STO120250035	2500/5 CL:3 5VA TOROİDAL AKIM TRAFOSU (SİMİT)	ADET	99,35 TL
STO120300035	3000/5 CL:3 5VA TOROİDAL AKIM TRAFOSU (SİMİT)	ADET	118,45 TL
STO120320035	3200/5 CL:3 5VA TOROİDAL AKIM TRAFOSU (SİMİT)	ADET	120,30 TL
STO120400035	4000/5 CL:3 5VA TOROİDAL AKIM TRAFOSU (SİMİT)	ADET	135,00 TL
STO120500035	5000/5 CL:3 5VA TOROİDAL AKIM TRAFOSU (SİMİT)	ADET	171,80 TL

TEK FAZLI ŞÖNT REAKTÖRLER / SINGLE PHASE SHUNT REACTOR



Ürün Kodu Product Code	Güç(kVar) Power	Gerilim(V) Voltage	I rms(A)	Ağırlık(Kg) Weight	Fiyat / \$ Price
SZG-ŞRM0,25	0,25	230	1,09	4,50	29,35 \$
SZG-ŞRM0,5	0,5	230	2,17	6,30	36,90 \$
SZG-ŞRM1	1	230	4,35	11,00	59,30 \$
SZG-ŞRM1,5	1,5	230	6,52	17,60	84,00 \$
SZG-ŞRM2	2	230	8,70	17,70	95,60 \$
SZG-ŞRM2,5	2,5	230	10,87	17,80	100,80 \$
SZG-ŞRM3	3	230	13,04	18,00	110,90 \$
SZG-ŞRM5	5	230	21,74	36,00	224,16 \$
SZG-ŞRM7,5	7,5	230	32,61	54,20	263,97 \$
SZG-ŞRM10	10	230	43,48	54,50	351,69 \$

ÜÇ FAZLI ŞÖNT REAKTÖRLER / THREE PHASE SHUNT REACTOR



Ürün Kodu Product Code	Güç(kVar) Power	Gerilim(V) Voltage	I rms(A)	Ağırlık(Kg) Weight	Fiyat / \$ Price
SZG-ŞRT0,25	0,25	400	0,36	5,80	69,30 \$
SZG-ŞRT0,5	0,5	400	0,72	10,10	82,55 \$
SZG-ŞRT1	1	400	1,44	11,00	92,90 \$
SZG-ŞRT1,5	1,5	400	2,17	11,50	100,25 \$
SZG-ŞRT2	2	400	2,89	19,40	132,70 \$
SZG-ŞRT2,5	2,5	400	3,62	19,48	153,40 \$
SZG-ŞRT3	3	400	4,34	19,50	182,90 \$
SZG-ŞRT5	5	400	7,24	31,00	237,43 \$
SZG-ŞRT7,5	7,5	400	10,86	38,20	302,00 \$
SZG-ŞRT10	10	400	14,49	63,50	460,10 \$
SZG-ŞRT15	15	400	21,73	64,20	473,40 \$
SZG-ŞRT20	20	400	28,98	92,60	681,30 \$
SZG-ŞRT25	25	400	36,23	92,75	675,10 \$
SZG-ŞRT30	30	400	43,47	96,40	750,20 \$
SZG-ŞRT40	40	400	57,97	160,10	1130,62 \$
SZG-ŞRT50	50	400	72,46	225,00	1282,02 \$

ÜÇ FAZLI HARMONİK FİLTRELER / THREE PHASE DETUNED HARMONIC FILTER



Ürün Kodu Product Code	Güç(kVar) Power	(P)	(V)	I rms(A)	Ağırlık(Kg) Weight	Fiyat / \$ Price
SZG-HF0,83	0,83	7 %	400	1,31	5,15	42,75 \$
SZG-HF1,0	1,0	7 %	400	1,59	5,20	45,70 \$
SZG-HF1,5	1,5	7%	400	2,38	5,15	47,20 \$
SZG-HF2,5	2,5	7 %	400	3,98	5,40	54,55 \$
SZG-HF4	4	7 %	400	6,37	6,18	63,40 \$
SZG-HF5	5	7 %	400	7,97	6,20	71,40 \$
SZG-HF6,25	6,25	7 %	400	9,96	6,30	82,90 \$
SZG-HF7,5	7,5	7 %	400	11,95	6,40	92,30 \$
SZG-HF10	10	7 %	400	15,94	7,60	110,50 \$
SZG-HF12,5	12,5	7 %	400	19,92	8,80	125,00 \$
SZG-HF15	15	7 %	400	23,91	14,20	132,70 \$
SZG-HF20	20	7 %	400	31,88	15,60	145,32 \$
SZG-HF25	25	7 %	400	39,85	15,68	149,50 \$
SZG-HF30	30	7 %	400	47,82	20,60	164,50 \$
SZG-HF40	40	7 %	400	63,76	31,20	201,50 \$
SZG-HF50	50	7 %	400	79,71	31,35	221,24 \$
SZG-HF75	75	7 %	400	119,57	63,30	325,84 \$
SZG-HF100	100	7 %	400	159,42	93,00	376,40 \$

TEK FAZLI ŞÖNT REAKTÖR BOYUT VE AĞIRLIK

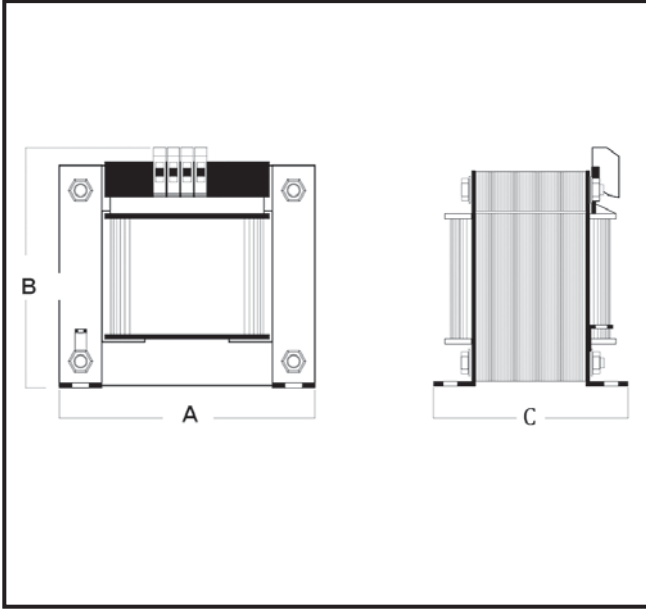

KVAr	A(mm)	B(mm)	C(mm)	AĞIRLIK(kg) WEIGHT(kg)
0,25	120	100	110	4,50
0,50	120	100	125	6,30
1	150	150	150	11,00
1,5	192	230	160	17,60
2	192	230	160	17,70
2,5	192	230	160	17,80
3	192	230	160	18,00
5	250	240	170	36,00
7,5	300	250	220	54,20
10	300	250	220	54,50

ÜÇ FAZLI ŞÖNT REAKTÖR BOYUT VE AĞIRLIK

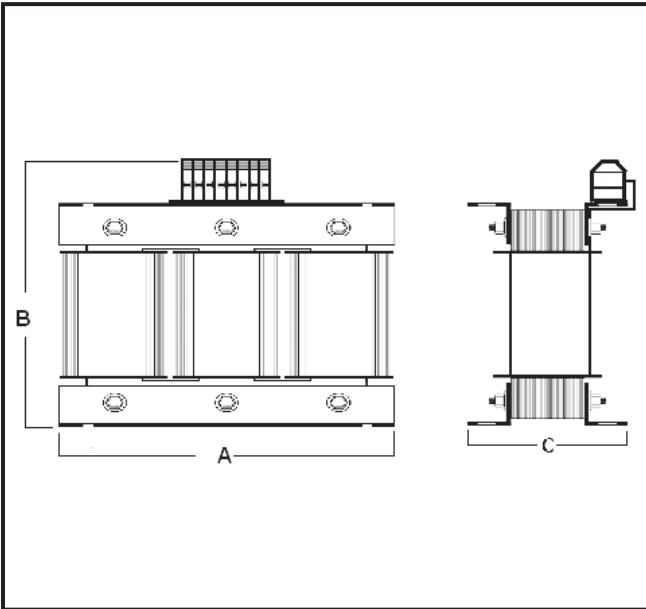

KVAr	A(mm)	B(mm)	C(mm)	AĞIRLIK(kg) WEIGHT(kg)
0,25	180	210	95	5,80
0,50	180	210	107	10,10
1	180	210	107	11,00
1,5	180	210	107	11,50
2	265	270	125	19,40
2,5	265	270	140	19,48
3	265	270	140	19,50
5	300	320	190	31,00
7,5	300	320	210	38,20
10	360	370	240	63,50
15	360	340	240	64,20
20	430	450	260	92,60
25	430	450	260	92,75
30	430	450	260	96,40
40	520	480	280	160,10
50	570	530	300	225,00

189 Hz p=%7 HARMONİK FİLTRE BOYUT VE AĞIRLIKLAR

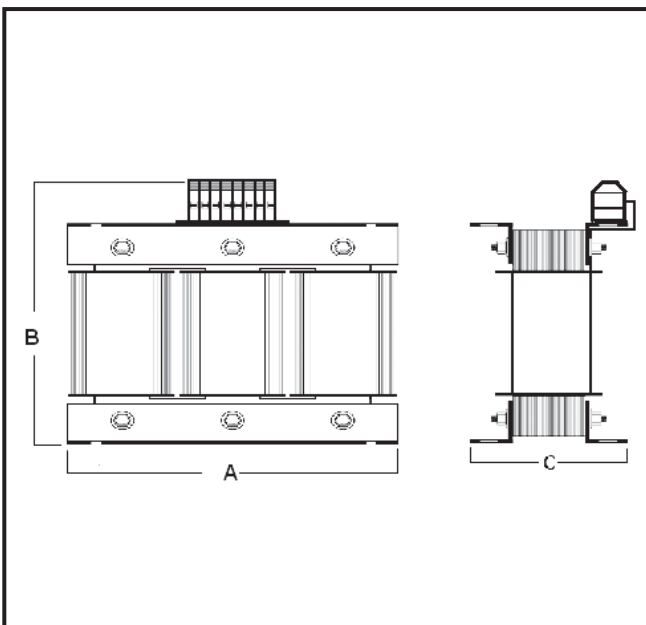

KVAr(Qc)	A(mm)	B(mm)	C(mm)	AĞIRLIK(kg) WEIGHT(kg)
0,83	180	210	95	5,15
1	180	210	95	5,20
1,5	180	210	95	5,15
2,5	180	210	95	5,40
4	180	210	105	6,18
5	180	210	105	6,20
6,25	180	210	105	6,30
7,5	180	210	105	6,40
10	180	210	106	7,60
12,5	180	210	107	8,80
15	230	240	130	14,20
20	230	240	140	15,60
25	230	240	140	15,68
30	230	240	155	20,60
40	295	320	160	31,20
50	295	320	160	31,35
75	360	385	190	63,30
100	420	440	225	93,00

KUMANDA TRAFOSU / CONTROL TRANSFORMER



ÜRÜN KODU PRODUCT CODE	AÇIKLAMA / STOK CİNSİ DESCRIPTION TYPE	BİRİM UNIT	FİYAT (TL) PRICE
SZG011100	230/24VAC 25VA KUMANDA TRAFOSU	ADET	45,25 TL
SZG011101	230/24VAC 50VA KUMANDA TRAFOSU	ADET	51,20 TL
SZG011102	230/24VAC 100VA KUMANDA TRAFOSU	ADET	70,45 TL
SZG011103	230/24VAC 150VA KUMANDA TRAFOSU	ADET	106,20 TL
SZG011104	230/24VAC 200VA KUMANDA TRAFOSU	ADET	122,30 TL
SZG011105	230/24VAC 250VA KUMANDA TRAFOSU	ADET	128,50 TL
SZG011106	230/24VAC 300VA KUMANDA TRAFOSU	ADET	156,85 TL
SZG011107	230/24VAC 400VA KUMANDA TRAFOSU	ADET	171,80 TL
SZG011108	230/24VAC 500VA KUMANDA TRAFOSU	ADET	225,50 TL
SZG011109	230/24VAC 630VA KUMANDA TRAFOSU	ADET	286,30 TL
SZG011110	400/24VAC 25VA KUMANDA TRAFOSU	ADET	46,25 TL
SZG011111	400/24VAC 50VA KUMANDA TRAFOSU	ADET	52,90 TL
SZG011112	400/24VAC 100VA KUMANDA TRAFOSU	ADET	72,90 TL
SZG011113	400/24VAC 150VA KUMANDA TRAFOSU	ADET	110,10 TL
SZG011114	400/24VAC 200VA KUMANDA TRAFOSU	ADET	126,25 TL
SZG011115	400/24VAC 250VA KUMANDA TRAFOSU	ADET	132,85 TL
SZG011116	400/24VAC 300VA KUMANDA TRAFOSU	ADET	163,30 TL
SZG011117	400/24VAC 400VA KUMANDA TRAFOSU	ADET	175,10 TL
SZG011118	400/24VAC 500VA KUMANDA TRAFOSU	ADET	234,10 TL
SZG011119	400/24VAC 630VA KUMANDA TRAFOSU	ADET	297,10 TL

* 630VA'den büyük trafolar için fiyat sorunuz.

İZOLASYON TRAFOSU / ISOLATING TRANSFORMER



ÜRÜN KODU PRODUCT CODE	AÇIKLAMA / STOK CİNSİ DESCRIPTION TYPE	BİRİM UNIT	FİYAT (TL) PRICE
SZG011200	230/230VAC 25VA İZOLASYON TRAFOSU	ADET	45,60 TL
SZG011201	230/230VAC 50VA İZOLASYON TRAFOSU	ADET	52,70 TL
SZG011202	230/230VAC 100VA İZOLASYON TRAFOSU	ADET	71,90 TL
SZG011203	230/230VAC 150VA İZOLASYON TRAFOSU	ADET	107,75 TL
SZG011204	230/230VAC 200VA İZOLASYON TRAFOSU	ADET	124,90 TL
SZG011205	230/230VAC 250VA İZOLASYON TRAFOSU	ADET	130,65 TL
SZG011206	230/230VAC 300VA İZOLASYON TRAFOSU	ADET	159,50 TL
SZG011207	230/230VAC 400VA İZOLASYON TRAFOSU	ADET	174,60 TL
SZG011208	230/230VAC 500VA İZOLASYON TRAFOSU	ADET	228,50 TL
SZG011209	230/230VAC 630VA İZOLASYON TRAFOSU	ADET	289,70 TL
SZG011210	400/230VAC 25VA İZOLASYON TRAFOSU	ADET	45,60 TL
SZG011211	400/230VAC 50VA İZOLASYON TRAFOSU	ADET	54,35 TL
SZG011212	400/230VAC 100VA İZOLASYON TRAFOSU	ADET	74,75 TL
SZG011213	400/230VAC 150VA İZOLASYON TRAFOSU	ADET	112,50 TL
SZG011214	400/230VAC 200VA İZOLASYON TRAFOSU	ADET	128,50 TL
SZG011215	400/230VAC 250VA İZOLASYON TRAFOSU	ADET	134,50 TL
SZG011216	400/230VAC 300VA İZOLASYON TRAFOSU	ADET	165,35 TL
SZG011217	400/230VAC 400VA İZOLASYON TRAFOSU	ADET	176,65 TL
SZG011218	400/230VAC 500VA İZOLASYON TRAFOSU	ADET	237,10 TL
SZG011219	400/230VAC 630VA İZOLASYON TRAFOSU	ADET	300,35 TL

* 630VA'den büyük trafolar için fiyat sorunuz.

AC SİLİNDİRİK TÜP KONDANSATÖRLER (Phicap PFC Serisi Trifaze Kondansatör)

V/Hz	ÜRÜN KODU	Güç / kVar	DxX	AĞIRLIK	KUTU ADETİ	FİYAT(€)
400V 50 Hz	MKP400-D-1.0	1.0	53x114	0.3	12	12.00 €
	MKP400-D-1.5	1.5	53x114	0.3	12	14.00 €
	MKP400-D-2.0	2.0	63.5x129	0.4	12	17.00 €
	MKP400-D-2.5	2.5	63.5x129	0.4	12	19.00 €
	MKP400-D-5.0	5.0	63.5x129	0.4	12	23.00 €
	MKP400-D-6.3	6.3	75x160	0.5		29.00 €
	MKP400-D-7.5	7.5	75x160	0.5		31.00 €
	MKP400-D-8.3	8.3	75x160	0.5		32.00 €
	MKP400-D-10.0	10.0	75x198	0.6		33.00 €
	MKP400-D-12.5	12.5	85x198	0.8	4	40.00 €
	MKP400-D-15.0	15.0	85x198	0.8	4	48.00 €
	MKP400-D-16.7	16.7	85x345	1.5	4	52.00 €
	MKP400-D-20.0	20.0	85x273	1.2	4	58.00 €
	MKP400-D-25.0	25.0	85x273	1.5	4	66.00 €
	MKP400-D-30.0	30.0	93.5x345	2.1	4	80.00 €
440V 50 Hz	MKP440-D-0.9	0.9	53x114	0.3	12	10.00 €
	MKP440-D-1.0	1.0	53x114	0.3	12	12.00 €
	MKP440-D-1.2	1.2	53x114	0.3	12	13.00 €
	MKP440-D-1.5	1.5	53x114	0.3	12	14.00 €
	MKP440-D-2.1	2.1	53x114	0.4	12	17.00 €
	MKP440-D-2.5	2.5	63.5x129	0.3	12	19.00 €
	MKP440-D-4.2	4.2	63.5x129	0.4	12	21.00 €
	MKP440-D-5.0	5.0	63.5x154	0.5	12	23.00 €
	MKP440-D-6.3	6.3	75x160	0.5		29.00 €
	MKP440-D-7.5	7.5	75x160	0.5		31.00 €
	MKP440-D-8.3	8.3	75x198	0.6		32.00 €
	MKP440-D-10.0	10.0	75x198	0.6		33.00 €
	MKP440-D-10.4	10.4	75x198	0.6		36.00 €
	MKP440-D-12.5	12.5	85x198	0.8	4	40.00 €
	MKP440-D-15.0	15.0	85x273	1.1	4	48.00 €
MKP440-D-16.7	16.7	85x273	1.2	4	52.00 €	
MKP440-D-20.8	20.8	85x273	1.2	4	60.00 €	
MKP440-D-25.0	25.0	85x348	1.5	4	66.00 €	
MKP440-D-28.0	28.0	85x348	1.5	4	76.00 €	
MKP440-D-30.0	30.0	85x348	1.6	4	80.00 €	
480V 50 Hz	MKP480-D-1.5	1.5	63.5x129	0.4	12	14.00 €
	MKP480-D-2.0	2.0	63.5x129	0.4	12	17.00 €
	MKP480-D-2.5	2.5	63.5x129	0.4	12	19.00 €
	MKP480-D-4.2	4.2	63.5x154	0.5	12	21.00 €
	MKP480-D-5.0	5.0	75x60	0.5		23.00 €
	MKP480-D-6.3	6.3	75x60	0.5		29.00 €
	MKP480-D-7.5	7.5	75x198	0.6		31.00 €
	MKP480-D-8.3	8.3	75x198	0.6		32.00 €
	MKP480-D-10.4	10.4	85x198	0.8	4	36.00 €
	MKP480-D-12.5	12.5	85x198	0.8	4	40.00 €
	MKP480-D-15.0	15.0	85x273	1.2	4	48.00 €
	MKP480-D-16.7	16.7	85x273	1.2	4	52.00 €
	MKP480-D-20.8	20.8	85x273	1.5	4	60.00 €
	MKP480-D-25.0	25.0	85x348	1.5	4	66.00 €
	MKP480-D-30.0	30.0	94x348	1.5	4	80.00 €



AC SİLİNDİRİK TÜP KONDANSATÖRLER (Phicap PFC Serisi Trifaze Kondansatör)

V/Hz	ÜRÜN KODU	Güç / kVAr	DxX	AĞIRLIK	KUTU ADETİ	FİYAT(€)
525V 50 Hz	MKP525-D-1.0	1.0	53x114	0.3	12	12.00 €
	MKP525-D-1.5	1.5	53x114	0.3	12	14.00 €
	MKP525-D-2.0	2.0	63.5x129	0.4	12	17.00 €
	MKP525-D-2.5	2.5	63.5x129	0.4	12	19.00 €
	MKP525-D-5.0	5.0	75x160	0.3		23.00 €
	MKP525-D-6.3	6.3	75x160	0.5		29.00 €
	MKP525-D-8.3	8.3	75x198	0.6		32.00 €
	MKP525-D-10.4	10.4	85x198	0.8	4	36.00 €
	MKP525-D-12.5	12.5	85x273	1.1	4	40.00 €
	MKP525-D-16.7	16.7	85x273	1.2	4	52.00 €
	MKP525-D-20.8	20.8	85x348	1.5	4	60.00 €
	MKP525-D-25.0	25.0	85x345	1.5	4	66.00 €



Not: 570V-690V-765V-800V-900V-1000V AC Kondansatörler için lütfen fiyat isteyiniz.

AC SİLİNDİRİK TÜP KONDANSATÖRLER (Phicap PFC Serisi Monofaze Kondansatör)

V/Hz	ÜRÜN KODU	Güç / kVAr	DxX	AĞIRLIK	KUTU ADETİ	FİYAT(€)
230V 50 Hz	MKP230- I -0.8	0.8	63.5x105	0.3	12	20.00 €
	MKP230- I -1.7	1.7	63.5x142	0.4	12	21.00 €
	MKP230- I -2.5	2.5	63.5x142	0.5	12	21.50 €



KOMPANZASYON KONTAKTÖRLERİ

V/Hz	ÜRÜN KODU	Güç / kVAr	Gerilim (V)	Bobin (V)	FİYAT(€)
400V 50/60 Hz	B44066S1011C240	10,0	380/415	220/230	22,00 €
	B44066S1211C240	12,5	380/415	220/230	23,00 €
	B44066S1611C240	16	380/415	220/230	27,00 €
	B44066S2011C240	20	380/415	220/230	43,00 €
	B44066S2511C240	25	380/415	220/230	44,00 €
	B44066S3311C240	33	380/415	220/230	78,00 €
	B44066S4011C240	40	380/415	220/230	82,00 €
	B44066S6011C240	60	380/415	220/230	97,00 €



ENDÜSTRİYEL ÜRÜNLER



DELİKLİ KABLO KANALI

ÜRÜN KODU	AÇIKLAMA / STOK CİNSİ	PAKET MİKTARI (mt)	FİYAT (TL)
SZG060001	SDK2540 25x40 DELİKLİ KABLO KANALI	50X2	5,55 TL
SZG060002	SDK2560 25x60 DELİKLİ KABLO KANALI	30X2	8,50 TL
SZG060003	SDK4040 40x40 DELİKLİ KABLO KANALI	26X2	7,75 TL
SZG060004	SDK4060 40x60 DELİKLİ KABLO KANALI	18X2	10,50 TL
SZG060005	SDK4080 40x80 DELİKLİ KABLO KANALI	20X2	14,60 TL
SZG060006	SDK6040 60x40 DELİKLİ KABLO KANALI	18X2	11,55 TL
SZG060007	SDK6060 60x60 DELİKLİ KABLO KANALI	12X2	14,90 TL
SZG060008	SDK6080 60x80 DELİKLİ KABLO KANALI	12X2	18,50 TL
SZG060009	SDK8060 80x60 DELİKLİ KABLO KANALI	14X2	15,95 TL
SZG060010	SDK8080 80x80 DELİKLİ KABLO KANALI	12X2	18,98 TL
SZG060011	SDK1060 100x60 DELİKLİ KABLO KANALI	10X2	22,15 TL
SZG060012	SDK1080 100x80 DELİKLİ KABLO KANALI	8X2	25,60 TL
SZG060020	SDK 25 LİK KANAL KAPAĞI	10X2	3,20 TL
SZG060021	SDK 40 LİK KANAL KAPAĞI	10X2	5,30 TL
SZG060022	SDK 60 LİK KANAL KAPAĞI	10X2	8,10 TL
SZG060023	SDK 80 LİK KANAL KAPAĞI	10X2	12,60 TL
SZG060024	SDK 100 LÜK KANAL KAPAĞI	10X2	17,60 TL



ISITICI

ÜRÜN KODU	AÇIKLAMA / STOK CİNSİ	PAKET MİKTARI	FİYAT (\$)
SZG0680001	SPI 15W PANO ISITICISI	1	24,00 \$
SZG0680002	SPI 30W PANO ISITICISI	1	24,00 \$
SZG0680003	SPI 45W PANO ISITICISI	1	33,00 \$
SZG0680004	SPI 60W PANO ISITICISI	1	33,00 \$
SZG0680005	SPI 75W PANO ISITICISI	1	42,00 \$
SZG0680006	SPI 100W PANO ISITICISI	1	47,00 \$
SZG0680007	SPI 150W PANO ISITICISI	1	49,00 \$
SZG0680008	SPI 250W PANO ISITICISI	1	106,00 \$
SZG0680009	SPI 400W PANO ISITICISI	1	120,00 \$
SZG0680010	SPI 750W PANO ISITICISI	1	220,00 \$



TEPE FANI

ÜRÜN KODU	AÇIKLAMA / STOK CİNSİ	PAKET MİKTARI	FİYAT (\$)
SZG0610000	STF Q150 TEPE FANI (360 m3/h)	1	54,00 \$
SZG0610001	STF Q190 TEPE FANI (600 m3/h)	1	83,00 \$
SZG0610002	STF Q220 TEPE FANI (1200 m3/h)	1	95,00 \$



TERMOSTAT

ÜRÜN KODU	AÇIKLAMA / STOK CİNSİ	PAKET MİKTARI	FİYAT (\$)
SZG0670000	STMC SOĞUK PANO TERMOSTADI	10	5,60 \$
SZG0670001	STMH SICAK PANO TERMOSTADI	10	5,60 \$



80A TOPRAKLAMA KLEMENSİ

ÜRÜN KODU	AÇIKLAMA / STOK CİNSİ	PAKET MİKTARI	FİYAT (TL)
SZG070000	4 DELİKLİ TOPRAKLAMA KLEMENSİ	250	1,75 TL
SZG070001	5 DELİKLİ TOPRAKLAMA KLEMENSİ	250	1,98 TL
SZG070002	6 DELİKLİ TOPRAKLAMA KLEMENSİ	250	2,31 TL
SZG070003	7 DELİKLİ TOPRAKLAMA KLEMENSİ	250	2,37 TL
SZG070004	9 DELİKLİ TOPRAKLAMA KLEMENSİ	200	3,10 TL
SZG070005	10 DELİKLİ TOPRAKLAMA KLEMENSİ	150	3,30 TL
SZG070006	12 DELİKLİ TOPRAKLAMA KLEMENSİ	150	3,85 TL
SZG070007	15 DELİKLİ TOPRAKLAMA KLEMENSİ	100	4,80 TL
SZG070008	22 DELİKLİ TOPRAKLAMA KLEMENSİ	100	7,15 TL
SZG070009	32 DELİKLİ TOPRAKLAMA KLEMENSİ	100	10,70 TL
SZG070010	42 DELİKLİ TOPRAKLAMA KLEMENSİ	50	14,85 TL
SZG070011	62 DELİKLİ TOPRAKLAMA KLEMENSİ	30	21,45 TL
SZG070012	82 DELİKLİ TOPRAKLAMA KLEMENSİ	30	28,10 TL



80A NÖTR KLEMENSİ (AYAKLI)

ÜRÜN KODU	AÇIKLAMA / STOK CİNSİ	PAKET MİKTARI	FİYAT (TL)
SZG071000	6 DELİKLİ NÖTR KLEMENSİ 80A (AYAKLI)	100	3,85 TL
SZG071001	7 DELİKLİ NÖTR KLEMENSİ 80A (AYAKLI)	100	4,35 TL
SZG071002	9 DELİKLİ NÖTR KLEMENSİ 80A (AYAKLI)	100	4,85 TL
SZG071003	10 DELİKLİ NÖTR KLEMENSİ 80A (AYAKLI)	100	5,10 TL
SZG071004	12 DELİKLİ NÖTR KLEMENSİ 80A (AYAKLI)	100	5,50 TL
SZG071005	15 DELİKLİ NÖTR KLEMENSİ 80A (AYAKLI)	100	6,20 TL
SZG071006	22 DELİKLİ NÖTR KLEMENSİ 80A (AYAKLI)	75	8,25 TL
SZG071007	32 DELİKLİ NÖTR KLEMENSİ 80A (AYAKLI)	50	12,10 TL
SZG071008	42 DELİKLİ NÖTR KLEMENSİ 80A (AYAKLI)	25	17,60 TL
SZG071009	62 DELİKLİ NÖTR KLEMENSİ 80A (AYAKLI)	14	23,60 TL
SZG071010	82 DELİKLİ NÖTR KLEMENSİ 80A (AYAKLI)	14	30,80 TL



80A NÖTR KLEMENSİ (AYAKSIZ)

ÜRÜN KODU	AÇIKLAMA / STOK CİNSİ	PAKET MİKTARI	FİYAT (TL)
SZG072000	6 DELİKLİ NÖTR KLEMENSİ 80A (AYAKSIZ)	250	3,30 TL
SZG072001	7 DELİKLİ NÖTR KLEMENSİ 80A (AYAKSIZ)	250	3,80 TL
SZG072002	9 DELİKLİ NÖTR KLEMENSİ 80A (AYAKSIZ)	200	4,35 TL
SZG072003	10 DELİKLİ NÖTR KLEMENSİ 80A (AYAKSIZ)	150	4,50 TL
SZG072004	12 DELİKLİ NÖTR KLEMENSİ 80A (AYAKSIZ)	150	4,90 TL
SZG072005	15 DELİKLİ NÖTR KLEMENSİ 80A (AYAKSIZ)	100	5,60 TL
SZG072006	22 DELİKLİ NÖTR KLEMENSİ 80A (AYAKSIZ)	100	7,70 TL
SZG072007	32 DELİKLİ NÖTR KLEMENSİ 80A (AYAKSIZ)	100	11,55 TL
SZG072008	42 DELİKLİ NÖTR KLEMENSİ 80A (AYAKSIZ)	50	17,10 TL
SZG072009	62 DELİKLİ NÖTR KLEMENSİ 80A (AYAKSIZ)	30	23,10 TL
SZG072010	82 DELİKLİ NÖTR KLEMENSİ 80A (AYAKSIZ)	30	30,25 TL



TOPRAKLAMA KLEMENSİ (1M)

ÜRÜN KODU	AÇIKLAMA / STOK CİNSİ	PAKET MİKTARI	FİYAT (TL)
SZG070013	1 METRE TOPRAKLAMA KLEMENSİ (80A)	80	56,50 TL
SZG070014	1 METRE TOPRAKLAMA KLEMENSİ (125A)	125	77,60 TL

125A NÖTR KLEMENSİ (AYAKLI)

ÜRÜN KODU	AÇIKLAMA / STOK CİNSİ	PAKET MİKTARI	FİYAT (TL)
SZG077000	6 DELİKLİ NÖTR KLEMENSİ 125A (AYAKLI)	100	5,50 TL
SZG077001	7 DELİKLİ NÖTR KLEMENSİ 125A (AYAKLI)	100	5,95 TL
SZG077002	9 DELİKLİ NÖTR KLEMENSİ 125A (AYAKLI)	100	7,05 TL
SZG077003	10 DELİKLİ NÖTR KLEMENSİ 125A (AYAKLI)	100	7,45 TL
SZG077004	12 DELİKLİ NÖTR KLEMENSİ 125A (AYAKLI)	100	8,50 TL
SZG077005	15 DELİKLİ NÖTR KLEMENSİ 125A (AYAKLI)	100	9,90 TL
SZG077006	22 DELİKLİ NÖTR KLEMENSİ 125A (AYAKLI)	75	13,75 TL
SZG077007	32 DELİKLİ NÖTR KLEMENSİ 125A (AYAKLI)	50	18,90 TL
SZG077008	42 DELİKLİ NÖTR KLEMENSİ 125A (AYAKLI)	25	28,95 TL
SZG077009	62 DELİKLİ NÖTR KLEMENSİ 125A (AYAKLI)	14	42,35 TL
SZG077010	82 DELİKLİ NÖTR KLEMENSİ 125A (AYAKLI)	14	50,80 TL



125A NÖTR KLEMENSİ (AYAKSIZ)

ÜRÜN KODU	AÇIKLAMA / STOK CİNSİ	PAKET MİKTARI	FİYAT (TL)
SZG078000	6 DELİKLİ NÖTR KLEMENSİ 125A (AYAKSIZ)	250	4,95 TL
SZG078001	7 DELİKLİ NÖTR KLEMENSİ 125A (AYAKSIZ)	250	5,40 TL
SZG078002	9 DELİKLİ NÖTR KLEMENSİ 125A (AYAKSIZ)	200	6,50 TL
SZG078003	10 DELİKLİ NÖTR KLEMENSİ 125A (AYAKSIZ)	150	6,90 TL
SZG078004	12 DELİKLİ NÖTR KLEMENSİ 125A (AYAKSIZ)	150	7,95 TL
SZG078005	15 DELİKLİ NÖTR KLEMENSİ 125A (AYAKSIZ)	100	9,35 TL
SZG078006	22 DELİKLİ NÖTR KLEMENSİ 125A (AYAKSIZ)	100	13,20 TL
SZG078007	32 DELİKLİ NÖTR KLEMENSİ 125A (AYAKSIZ)	100	18,40 TL
SZG078008	42 DELİKLİ NÖTR KLEMENSİ 125A (AYAKSIZ)	50	28,40 TL
SZG078009	62 DELİKLİ NÖTR KLEMENSİ 125A (AYAKSIZ)	30	41,80 TL
SZG078010	82 DELİKLİ NÖTR KLEMENSİ 125A (AYAKSIZ)	30	50,30 TL



OTOMAT BARASI

ÜRÜN KODU	AÇIKLAMA / STOK CİNSİ	PAKET MİKTARI	FİYAT (TL)
SZG0800113	1mm TRİFAZE OTOMAT BARASI (53cm)	25	33,00 TL
SZG0800114	1mm TRİFAZE OTOMAT BARASI (106cm)	25	66,00 TL
SZG0800115	1,5mm TRİFAZE OTOMAT BARASI (53cm)	25	46,20 TL
SZG0800116	1,5mm TRİFAZE OTOMAT BARASI (106cm)	25	92,00 TL
SZG0800117	OTOMAT BARA YAN KAPAK	100	0,30 TL
SZG0800118	1mm MONOFAZE OTOMAT BARASI (53cm)	100	13,75 TL
SZG0800119	1mm MONOFAZE OTOMAT BARASI (106cm)	50	27,50 TL
SZG0800120	1,5mm MONOFAZE OTOMAT BARASI (53cm)	100	16,50 TL
SZG0800121	1,5mm MONOFAZE OTOMAT BARASI (106cm)	50	30,80 TL



OTOMAT RAYI

ÜRÜN KODU	AÇIKLAMA / STOK CİNSİ	PAKET MİKTARI	FİYAT (TL)
SZG079008	35x7,5 DELİKLİ OTOMAT RAYI (1 MT)	50	4,20 TL
SZG079009	35x7,5 DELİKLİ OTOMAT RAYI (2 MT)	25	8,40 TL
SZG079014	RAY TAŞIYICI	25	2,10 TL



DAĞITIM ÜNİTESİ

ÜRÜN KODU	AÇIKLAMA / STOK CİNSİ	PAKET MİKTARI	FİYAT (TL)
SZG076000	7 DELİKLİ 80A DAĞITIM ÜNİTESİ (2 KUTUPLU)	30	13,65 TL
SZG076001	10 DELİKLİ 80A DAĞITIM ÜNİTESİ (2 KUTUPLU)	20	16,30 TL
SZG076002	12 DELİKLİ 80A DAĞITIM ÜNİTESİ (2 KUTUPLU)	20	17,00 TL
SZG076003	15 DELİKLİ 80A DAĞITIM ÜNİTESİ (2 KUTUPLU)	20	20,50 TL
SZG076004	20 DELİKLİ 80A DAĞITIM ÜNİTESİ (2 KUTUPLU)	10	25,75 TL
SZG076005	22 DELİKLİ 80A DAĞITIM ÜNİTESİ (2 KUTUPLU)	10	27,90 TL
SZG076006	25 DELİKLİ 80A DAĞITIM ÜNİTESİ (2 KUTUPLU)	10	30,90 TL
SZG076007	7 DELİKLİ 80A DAĞITIM ÜNİTESİ (3 KUTUPLU)	15	18,25 TL
SZG076008	10 DELİKLİ 80A DAĞITIM ÜNİTESİ (3 KUTUPLU)	10	22,50 TL
SZG076009	12 DELİKLİ 80A DAĞITIM ÜNİTESİ (3 KUTUPLU)	10	24,75 TL
SZG076010	15 DELİKLİ 80A DAĞITIM ÜNİTESİ (3 KUTUPLU)	10	28,90 TL
SZG076011	20 DELİKLİ 80A DAĞITIM ÜNİTESİ (3 KUTUPLU)	6	37,30 TL
SZG076012	22 DELİKLİ 80A DAĞITIM ÜNİTESİ (3 KUTUPLU)	6	40,55 TL
SZG076013	25 DELİKLİ 80A DAĞITIM ÜNİTESİ (3 KUTUPLU)	6	44,10 TL
SZG076014	7 DELİKLİ 80A DAĞITIM ÜNİTESİ (4 KUTUPLU)	15	21,00 TL
SZG076015	10 DELİKLİ 80A DAĞITIM ÜNİTESİ (4 KUTUPLU)	10	26,25 TL
SZG076016	12 DELİKLİ 80A DAĞITIM ÜNİTESİ (4 KUTUPLU)	10	31,50 TL
SZG076017	15 DELİKLİ 80A DAĞITIM ÜNİTESİ (4 KUTUPLU)	10	36,75 TL
SZG076018	20 DELİKLİ 80A DAĞITIM ÜNİTESİ (4 KUTUPLU)	6	44,10 TL
SZG076019	22 DELİKLİ 80A DAĞITIM ÜNİTESİ (4 KUTUPLU)	6	47,25 TL
SZG076020	25 DELİKLİ 80A DAĞITIM ÜNİTESİ (4 KUTUPLU)	6	52,50 TL
SZG073000	7 DELİKLİ 125A DAĞITIM ÜNİTESİ (2 KUTUPLU)	22	14,70 TL
SZG073001	10 DELİKLİ 125A DAĞITIM ÜNİTESİ (2 KUTUPLU)	15	17,70 TL
SZG073002	12 DELİKLİ 125A DAĞITIM ÜNİTESİ (2 KUTUPLU)	14	21,50 TL
SZG073003	15 DELİKLİ 125A DAĞITIM ÜNİTESİ (2 KUTUPLU)	12	25,20 TL
SZG073004	20 DELİKLİ 125A DAĞITIM ÜNİTESİ (2 KUTUPLU)	6	31,25 TL
SZG073005	22 DELİKLİ 125A DAĞITIM ÜNİTESİ (2 KUTUPLU)	6	33,60 TL
SZG073006	25 DELİKLİ 125A DAĞITIM ÜNİTESİ (2 KUTUPLU)	6	37,30 TL
SZG074000	7 DELİKLİ 125A DAĞITIM ÜNİTESİ (3 KUTUPLU)	22	21,00 TL
SZG074001	10 DELİKLİ 125A DAĞITIM ÜNİTESİ (3 KUTUPLU)	15	26,25 TL
SZG074002	12 DELİKLİ 125A DAĞITIM ÜNİTESİ (3 KUTUPLU)	14	31,50 TL
SZG074003	15 DELİKLİ 125A DAĞITIM ÜNİTESİ (3 KUTUPLU)	12	36,75 TL
SZG074004	20 DELİKLİ 125A DAĞITIM ÜNİTESİ (3 KUTUPLU)	6	44,10 TL
SZG074005	22 DELİKLİ 125A DAĞITIM ÜNİTESİ (3 KUTUPLU)	6	47,25 TL
SZG074006	25 DELİKLİ 125A DAĞITIM ÜNİTESİ (3 KUTUPLU)	6	52,50 TL
SZG075000	7 DELİKLİ 125A DAĞITIM ÜNİTESİ (4 KUTUPLU)	22	26,25 TL
SZG075001	10 DELİKLİ 125A DAĞITIM ÜNİTESİ (4 KUTUPLU)	15	32,60 TL
SZG075002	12 DELİKLİ 125A DAĞITIM ÜNİTESİ (4 KUTUPLU)	14	39,65 TL
SZG075003	15 DELİKLİ 125A DAĞITIM ÜNİTESİ (4 KUTUPLU)	12	46,80 TL
SZG075004	20 DELİKLİ 125A DAĞITIM ÜNİTESİ (4 KUTUPLU)	6	58,70 TL
SZG075005	22 DELİKLİ 125A DAĞITIM ÜNİTESİ (4 KUTUPLU)	6	63,55 TL
SZG075006	25 DELİKLİ 125A DAĞITIM ÜNİTESİ (4 KUTUPLU)	6	70,40 TL



SİNYAL LAMBASI

ÜRÜN KODU	AÇIKLAMA / STOK CİNSİ	PAKET MİKTARI	FİYAT (TL)
SZG0810010	Q22 SİNYAL LAMBASI 220VAC KIRMIZI (LEDLİ)	20	2,50 TL
SZG0810011	Q22 SİNYAL LAMBASI 220VAC YEŞİL (LEDLİ)	20	2,50 TL
SZG0810012	Q22 SİNYAL LAMBASI 220VAC SARI (LEDLİ)	20	2,50 TL
SZG0810013	Q22 SİNYAL LAMBASI 220VAC MAVİ (LEDLİ)	20	2,80 TL
SZG0810014	Q22 SİNYAL LAMBASI 220VAC BEYAZ (LEDLİ)	20	2,80TL
SZG0810020	Q22 SİNYAL LAMBASI 24VAC/DC KIRMIZI (LEDLİ)	20	2,50 TL
SZG0810021	Q22 SİNYAL LAMBASI 24VAC/DC YEŞİL (LEDLİ)	20	2,50 TL
SZG0810022	Q22 SİNYAL LAMBASI 24VAC/DC SARI (LEDLİ)	20	2,50 TL
SZG0810023	Q22 SİNYAL LAMBASI 24VAC/DC MAVİ (LEDLİ)	20	2,80 TL
SZG0810024	Q22 SİNYAL LAMBASI 24VAC/DC BEYAZ (LEDLİ)	20	2,80 TL
SZG0810030	Q22 SİNYAL LAMBASI 110VAC KIRMIZI (LEDLİ)	20	2,50 TL
SZG0810031	Q22 SİNYAL LAMBASI 110VAC YEŞİL (LEDLİ)	20	2,50 TL
SZG0810032	Q22 SİNYAL LAMBASI 110VAC SARI (LEDLİ)	20	2,50 TL
SZG0810033	Q22 SİNYAL LAMBASI 110VAC MAVİ (LEDLİ)	20	2,80 TL
SZG0810034	Q22 SİNYAL LAMBASI 110VAC BEYAZ (LEDLİ)	20	2,80 TL

STANDART TİP SKP KABLO PABUCU

ÜRÜN KODU	AÇIKLAMA / STOK CİNSİ	PAKET MİKTARI	FİYAT (TL)
SZG080000	6mm/M4 STANDART TİP SKP KABLO PABUCU	500	0,54 TL
SZG080001	10mm/M5 STANDART TİP SKP KABLO PABUCU	400	0,71 TL
SZG080002	10mm/M6 STANDART TİP SKP KABLO PABUCU	400	0,74TL
SZG080003	10mm/M8 STANDART TİP SKP KABLO PABUCU	400	0,78 TL
SZG080004	16mm/M6 STANDART TİP SKP KABLO PABUCU	350	1,05TL
SZG080005	16mm/M8 STANDART TİP SKP KABLO PABUCU	350	1,11TL
SZG080006	25mm/M8 STANDART TİP SKP KABLO PABUCU	300	1,79 TL
SZG080007	25mm/M10 STANDART TİP SKP KABLO PABUCU	300	1,85 TL
SZG080008	35mm/M8 STANDART TİP SKP KABLO PABUCU	200	2,52 TL
SZG080009	35mm/M10 STANDART TİP SKP KABLO PABUCU	200	2,62 TL
SZG080010	50mm/M10 STANDART TİP SKP KABLO PABUCU	150	3,80 TL
SZG080011	70mm/M10 STANDART TİP SKP KABLO PABUCU	100	4,81 TL
SZG080012	95mm/M12 STANDART TİP SKP KABLO PABUCU	50	6,02 TL
SZG080013	120mm/M12 STANDART TİP SKP KABLO PABUCU	50	8,67 TL
SZG080014	150mm/M12 STANDART TİP SKP KABLO PABUCU	40	13,78 TL
SZG080015	185mm/M16 STANDART TİP SKP KABLO PABUCU	30	16,13 TL
SZG080016	240mm/M16 STANDART TİP SKP KABLO PABUCU	25	21,50 TL

LED'Lİ BANT ARMATÜRLER

ÜRÜN KODU	AÇIKLAMA / STOK CİNSİ	PAKET MİKTARI	FİYAT (\$)
SZG082000	5W LED'Lİ BANT ARMATÜR (220V)	1	9,00 \$
SZG082001	9W LED'Lİ BANT ARMATÜR (220V)	1	11,00 \$
SZG082002	14W LED'Lİ BANT ARMATÜR (220V)	1	13,00 \$
SZG082003	18W LED'Lİ BANT ARMATÜR (220V)	1	16,00 \$

DARALAN MAKARON

ÜRÜN KODU	AÇIKLAMA / STOK CİNSİ	PAKET MİKTARI	FİYAT (\$)
SZG90001	1MM DARALAN MAKARON	200	0,088 \$
SZG90002	1,5MM DARALAN MAKARON	200	0,088 \$
SZG90003	1,6MM DARALAN MAKARON	200	0,088 \$
SZG90004	2MM DARALAN MAKARON	200	0,088 \$
SZG90005	2,4MM DARALAN MAKARON	200	0,100 \$
SZG90006	2,5MM DARALAN MAKARON	200	0,108 \$
SZG90007	3MM DARALAN MAKARON	200	0,125 \$
SZG90008	3,2MM DARALAN MAKARON	200	0,125 \$
SZG90009	3,5MM DARALAN MAKARON	200	0,129 \$
SZG90010	4MM DARALAN MAKARON	200	0,153 \$
SZG90011	4,5MM DARALAN MAKARON	100	0,168 \$
SZG90012	4,8MM DARALAN MAKARON	100	0,168 \$
SZG90013	5MM DARALAN MAKARON	100	0,192 \$
SZG90014	6MM DARALAN MAKARON	100	0,224 \$
SZG90015	6,4MM DARALAN MAKARON	100	0,224 \$
SZG90016	7MM DARALAN MAKARON	100	0,265 \$
SZG90017	8MM DARALAN MAKARON	100	0,268 \$
SZG90018	9,5MM DARALAN MAKARON	100	0,273 \$
SZG90019	10MM DARALAN MAKARON	100	0,289 \$
SZG90020	12,7MM DARALAN MAKARON	100	0,338 \$
SZG90021	13MM DARALAN MAKARON	100	0,370 \$
SZG90022	16MM DARALAN MAKARON	100	0,579 \$
SZG90023	18MM DARALAN MAKARON	100	0,754 \$
SZG90024	19,1MM DARALAN MAKARON	100	0,754 \$
SZG90025	20MM DARALAN MAKARON	100	0,932 \$
SZG90026	22MM DARALAN MAKARON	100	1,156 \$
SZG90027	25,4MM DARALAN MAKARON	50	1,204 \$
SZG90028	30MM DARALAN MAKARON	50	1,767 \$
SZG90029	32MM DARALAN MAKARON	50	1,847 \$
SZG90030	35MM DARALAN MAKARON	50	2,377 \$
SZG90031	38MM DARALAN MAKARON	50	2,570 \$
SZG90032	40MM DARALAN MAKARON	50	2,618 \$
SZG90033	51MM DARALAN MAKARON	25	3,533 \$
SZG90034	60MM DARALAN MAKARON	25	5,059 \$
SZG90035	70MM DARALAN MAKARON	25	6,585 \$
SZG90036	80MM DARALAN MAKARON	25	7,645 \$
SZG90037	102MM DARALAN MAKARON	25	9,315 \$
SZG90038	120MM DARALAN MAKARON	20	13,650 \$
SZG90039	150MM DARALAN MAKARON	20	20,075 \$
SZG90040	180MM DARALAN MAKARON	20	27,300 \$



SERTİFİKALAR

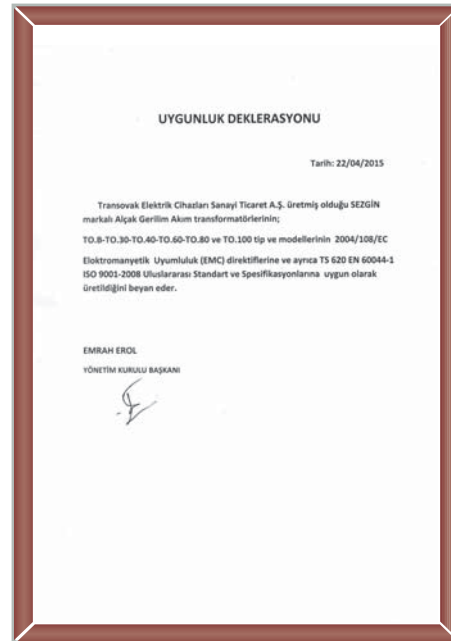

ÇÖZÜM ORTAKLARIMIZ

 **wieland**

Klemsan®

 **Cetinkaya**
Pano

EPCOS

GWEST®
www.gwest.com.tr

LS

E/NTES

 **KÖHLER**
ELEKTRİK SAYAÇLARI SAN. VE TİC. A.Ş.

 **öznur kablo**

 **borsan®**

 **erse**

 **SEVAL KABLO**
kuruluş 1990



Üreten Ülke Güçlüdür...

EROLLAR İNŞ. TAAH. ve ELEK. MALZ. SAN. TIC. LTD. ŞTİ.

Merkez:

Perpa Ticaret Merkezi B Blok Kat:2 No:85 Okmeydanı - Şişli / İSTANBUL

Tel: (0212) 255 11 80 - 235 37 27 Fax: (0212) 255 53 68

Fabrika:

Maltepe Mah. Çiftelahuzlar Yolu Sema Sanayi Sit.

No:7/5-6-7-8 Zeytinburnu / İSTANBUL

Tel: (0212) 482 92 32

www.sezgin.web.tr • info@sezgin.web.tr